

RS SERIES

The RS-series is a rotary air blower with a three-blade rotor. A highly well-balanced rotor and innovative helical outlet port minimizes violent impact and pulsation noise. It is applicable to a wide variety of applications.

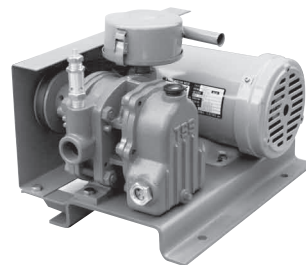

RSS
(Discharge Bore 20, 25, 32mm)

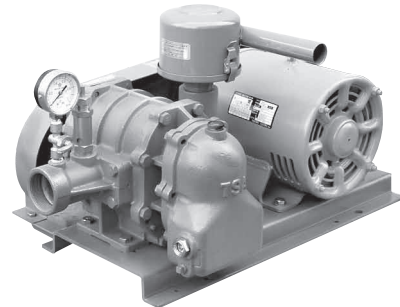

RSA
(Discharge Bore 40, 50, 65mm)

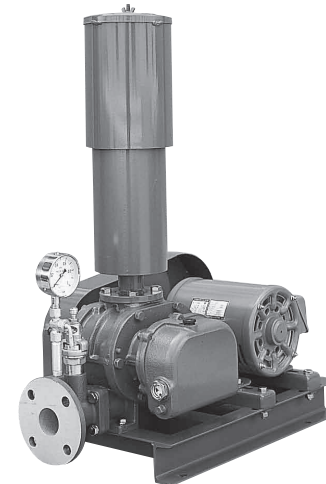

RSR
(Discharge Bore 50, 65, 80, 100, 125, 150mm)

Applications

- Supplying oxygen to wastewater in aeration tank
- Supplying oxygen in aquaculture

Structural Features

Innovative Helical Intake / Outlet

Conventional blowers were designed to discharge the air from the casing in a gust. This caused violent impact and pulsation and resultant noise. Tsurumi blowers have helical structure at the intake and the outlet. This makes the air virtually pass through a gradually closing suction port or gradually opening discharge port. The result is remarkably reduced pulsation noise.

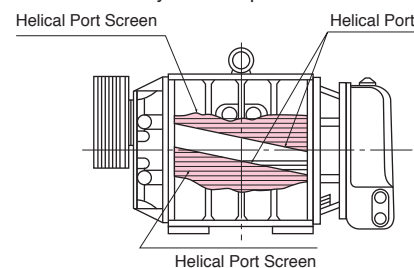

Helical Port

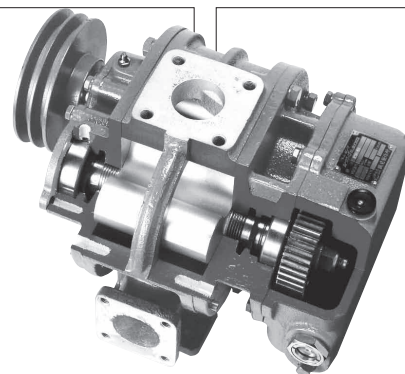
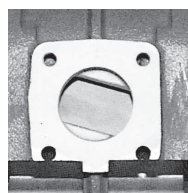

Special Silencer and 3-lobe Rotor

A specially prepared silencer absorbs a broad range of noise frequencies from low to high. The air flow rate and pressure characteristics have been greatly upgraded by the adoption of a 3-lobe rotor with each blade deliberately displaced as to thrust direction to avoid mutual contact.



Rotor

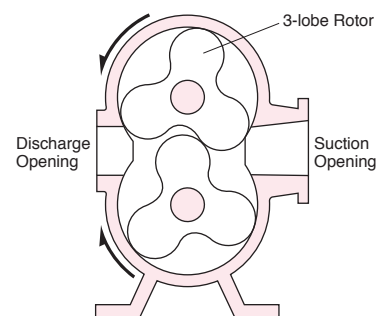

Reference Drawing for Piping (example)

RSS · RSA

Optional accessories

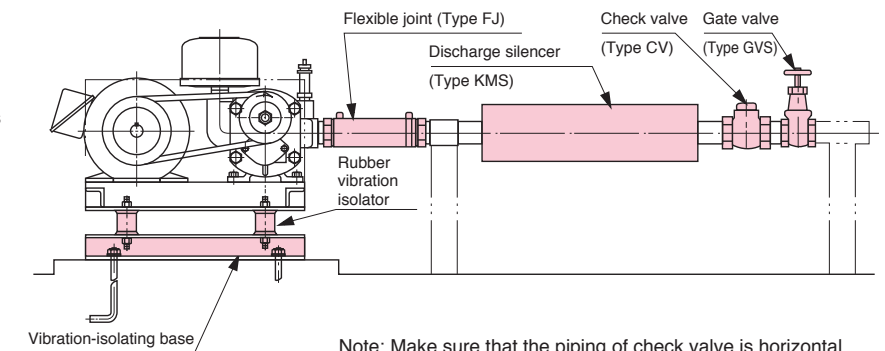

Note: Make sure that the piping of check valve is horizontal.

HOW TO USE THE PERFORMANCE TABLE

Information about 50/60Hz Standard Specification Tables

These tables indicate the relationships among blower models, bores, rpm, discharge pressure, actual air flow rates, and shaft power.

1. The amounts of air indicated in the tables represent suction amounts under the following standard suction conditions: temperature, 20°C; absolute pressure, 101.3kPa {1.033kgf / cm²}; relative humidity, 65%.
2. The amounts of air under reference suction conditions (temperature, 0°C; absolute pressure, 101.3kPa {1.033kgf / cm²}) can be converted into the amounts of air under the standard suction conditions by the formula below if the suction pressures are the same:

$$Q_s = Q_n \times \frac{273 + t_s}{273}$$

where
 Q_s, amount of air (m³ / min) under standard suction conditions indicated on Standard Specification Tables;
 Q_n, amount of air (m³ / min) under reference suction conditions;
 Suction pressure is ambient pressure, 101.3kPa; t_s, suction temperature in °C.

3. To convert the amounts of air under discharge conditions into the amounts of air under the standard suction conditions indicated on the Standard Specification Tables, use the following formula:

$$Q_s = Q_d \times \frac{101.3 + P_d}{101.3} \times \frac{273 + t_s}{273 + t_d}$$

where
 Q_d, amount of air (m³ / min) under discharge conditions;
 P_d, discharge pressure (kPa);
 t_s, suction temperature in °C;
 t_d, discharge temperature in °C.

4. Using the amount of air and the necessary discharge pressure obtained from the above mathematics, determine your blower model, bore, rpm, and shaft power in reference to a Standard Specification Table.
5. Your selectable range can be overlapped over several models. It is recommended that the one with a younger model number for cost economy, or with a larger model number for lower noise, be selected.
6. Motor output is identified by color on the Standard Specification Tables. Select a suitable color motor from these tables.

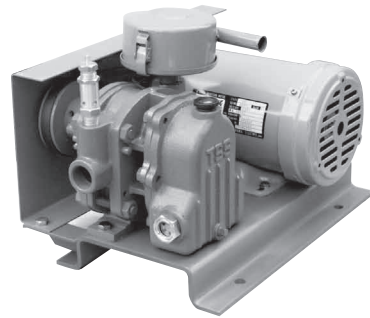

Performance Curves

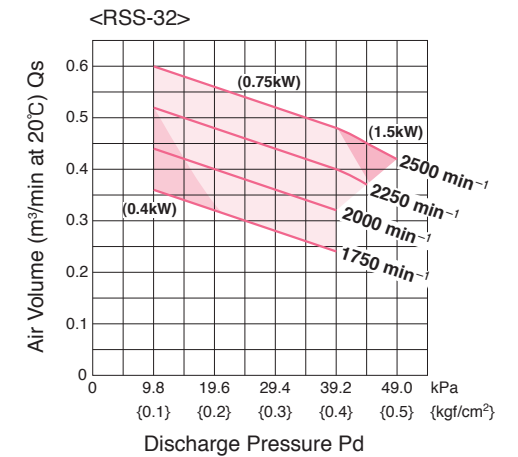
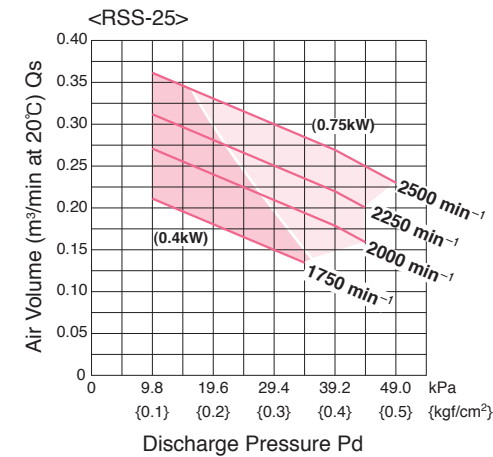
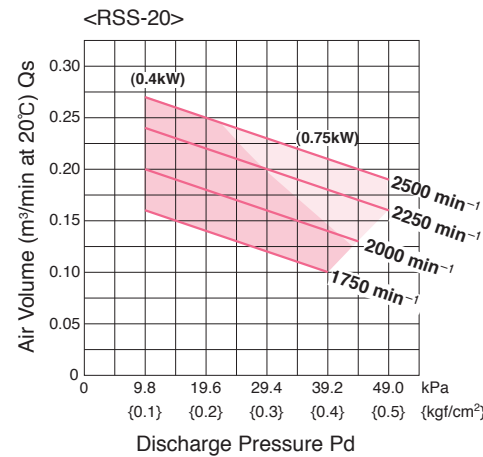

Applications

- Supplying oxygen to wastewater in aeration tank
- Supplying oxygen in aquaculture

Noise Level (1.0m on machine side)

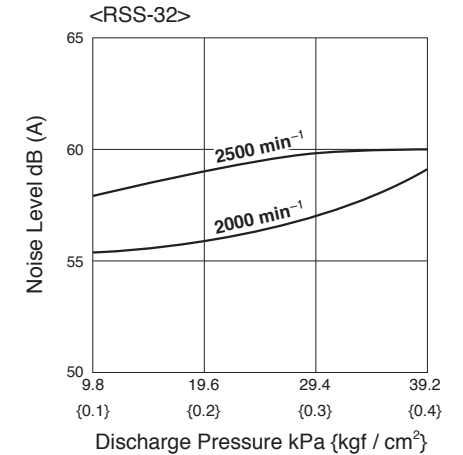
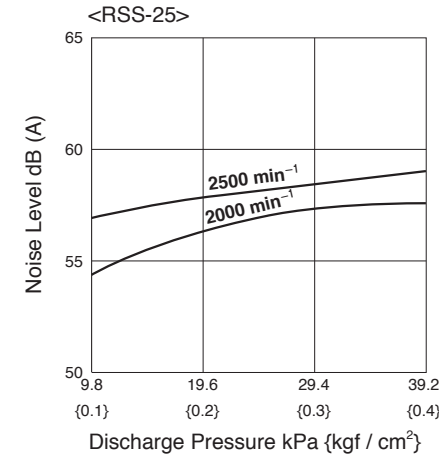
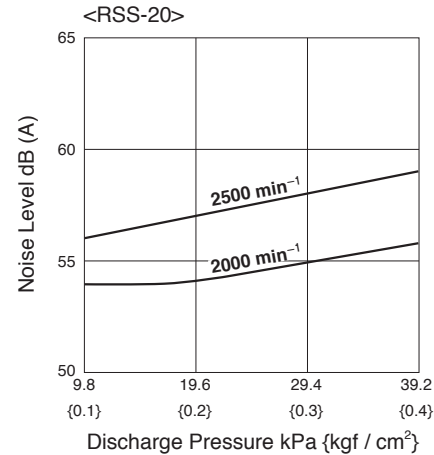

Major Standard Specifications

Discharge Bore		mm	20	25	32
Treating Fluid	Type of Fluid	Air			
	Fluid Temperature	0 to 40°C			
Blower	Structure	Rotor	3-lode Helical Port		
		Shaft Seal	Labyrinth		
		Bearing	Ball Bearing		
	Materials	Rotor	Gray Iron Casting		
Casing		Gray Iron Casting			
	Shaft	Carbon Steel			
Motor	Type, Pole	Drip-proof Motor			
		4-pole			
	Class of Insulation	Class E			
	Phase	Single-phase (0.4kW only) Three-phase			
Discharge Connection		Screw (ISO Rc-type)			

Standard Specifications

Model (Discharge bore mm)	Revolutions (min ⁻¹)	Suction air volume at 20°C (Qs, m ³ /min) and required power (La, kW)										
		9.8kPa {0.1kgf/cm ² }		19.6kPa {0.2kgf/cm ² }		29.4kPa {0.3kgf/cm ² }		39.2kPa {0.4kgf/cm ² }		49.0kPa {0.5kgf/cm ² }		
		Qs	La	Qs	La	Qs	La	Qs	La	Qs	La	
RSS-20 (20)	1750	0.16	0.20	0.14	0.24	0.12	0.28	0.10	0.32	—	—	
	2000	0.20	0.23	0.18	0.27	0.16	0.31	0.14	0.35	—	—	
	2250	0.24	0.26	0.22	0.31	0.20	0.35	0.18	0.40	0.16	0.46	
	2500	0.27	0.29	0.25	0.34	0.23	0.39	0.21	0.44	0.19	0.50	
Corresponding motor output		0.4kW					0.75kW					
RSS-25 (25)	1750	0.21	0.23	0.18	0.27	0.15	0.32	—	—	—	—	
	2000	0.27	0.26	0.24	0.31	0.21	0.37	0.18	0.43	—	—	
	2250	0.31	0.30	0.28	0.35	0.25	0.42	0.22	0.49	—	—	
	2500	0.36	0.33	0.33	0.39	0.30	0.46	0.27	0.54	0.23	0.62	
Corresponding motor output		0.4kW					0.75kW					
RSS-32 (32)	1750	0.36	0.27	0.32	0.34	0.28	0.42	0.24	0.50	—	—	
	2000	0.44	0.31	0.40	0.39	0.36	0.48	0.32	0.57	—	—	
	2250	0.52	0.35	0.48	0.44	0.44	0.54	0.40	0.64	—	—	
	2500	0.60	0.39	0.56	0.49	0.52	0.60	0.48	0.71	0.42	0.86	
Corresponding motor output		0.4kW					0.75kW					1.5kW

Standard Accessories

- Common Base
- Suction Silencer (with Air Filter)
- Safety Valve
- Foundation Bolts (with Nuts)

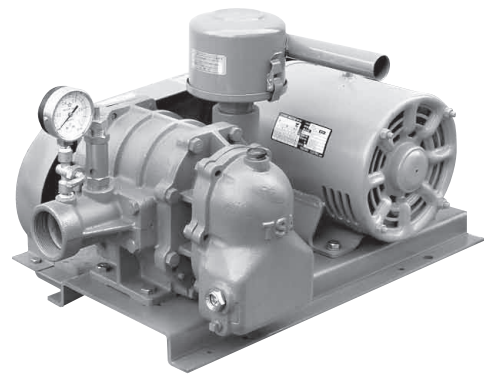

Performance Curves

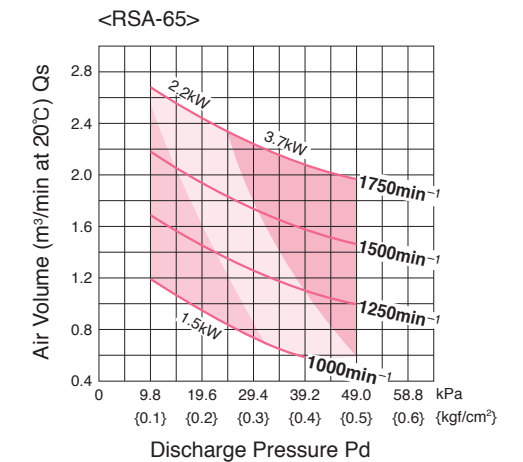
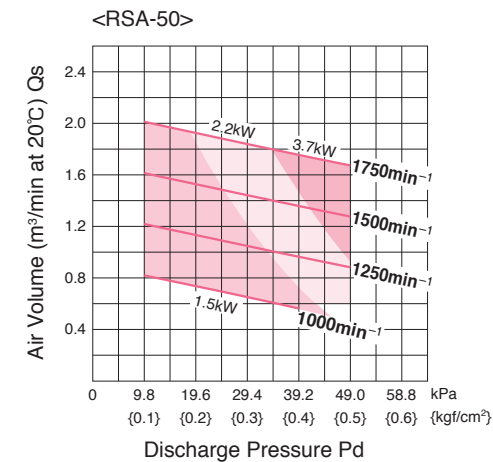
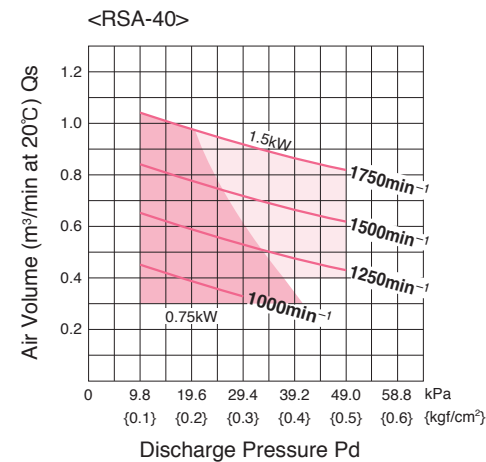

Applications

- Supplying oxygen to wastewater in aeration tank
- Supplying oxygen in aquaculture

Noise Level (1.0m on machine side)

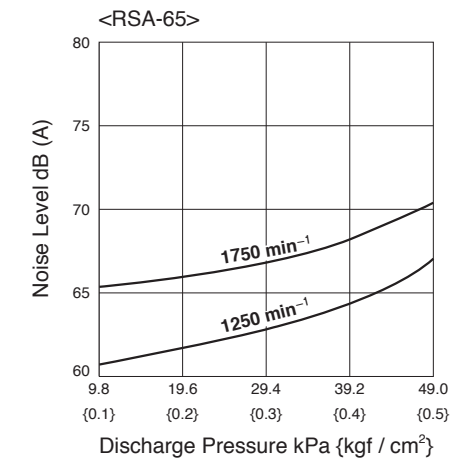
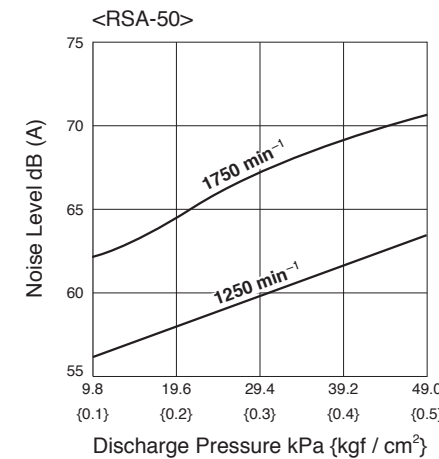
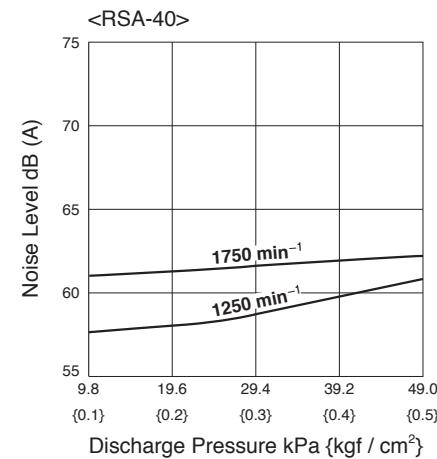

Major Standard Specifications

Discharge Bore		mm	40	50	65
Treating Fluid	Type of Fluid	Air			
	Fluid Temperature	0 to 40°C			
Blower	Structure	Rotor	3-lode Helical Port		
		Shaft Seal	Labyrinth		
		Bearing	Ball Bearing		
	Materials	Rotor	Gray Iron Casting		
Shaft		Carbon Steel			
Motor	Type, Pole	Drip-proof Motor			
		4-pole			
	Class of Insulation	Class E			
	Phase	Three-phase			
Discharge Connection		Screw (ISO Rc-type)			

Standard Specifications

Model (Discharge bore mm)	Revolutions (min ⁻¹)	Suction air volume at 20°C (Qs, m ³ /min) and required power (La, kW)									
		9.8kPa {0.1kgf/cm ² }		19.6kPa {0.2kgf/cm ² }		29.4kPa {0.3kgf/cm ² }		39.2kPa {0.4kgf/cm ² }		49.0kPa {0.5kgf/cm ² }	
		Qs	La	Qs	La	Qs	La	Qs	La	Qs	La
RSA-40 (40)	1000	0.45	0.32	0.39	0.40	0.33	0.52	—	—	—	—
	1250	0.65	0.40	0.59	0.50	0.53	0.65	0.48	0.80	0.43	0.99
	1500	0.84	0.48	0.78	0.60	0.72	0.78	0.67	0.96	0.62	1.18
	1750	1.04	0.56	0.98	0.70	0.92	0.91	0.87	1.11	0.82	1.38
Corresponding motor output		0.75kW					1.5kW				
RSA-50 (50)	1000	0.82	0.64	0.73	0.80	0.65	1.04	0.57	1.28	—	—
	1250	1.22	0.80	1.13	1.00	1.05	1.30	0.97	1.60	0.89	1.97
	1500	1.61	0.96	1.52	1.20	1.44	1.56	1.36	1.92	1.28	2.36
	1750	2.01	1.12	1.92	1.40	1.84	1.82	1.76	2.22	1.68	2.76
Corresponding motor output		1.5kW			2.2kW			3.7kW			
RSA-65 (65)	1000	1.19	0.80	0.94	1.00	0.75	1.30	0.59	1.60	—	—
	1250	1.69	1.00	1.45	1.25	1.26	1.63	1.10	2.00	0.99	2.45
	1500	2.18	1.20	1.93	1.50	1.74	1.95	1.58	2.40	1.47	2.95
	1750	2.68	1.40	2.43	1.75	2.24	2.28	2.08	2.78	1.97	3.45
Corresponding motor output		1.5kW			2.2kW			3.7kW			

Standard Accessories

- Common Base
- Suction Silencer (with Air Filter)
- Safety Valve
- Pressure Gauge
- Foundation Bolts (with Nuts)

RSR 50 • 65mm



Performance Curves

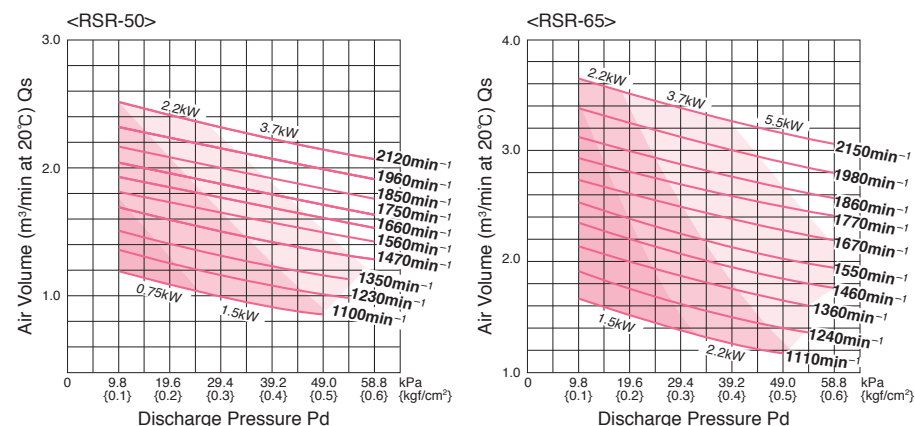

Noise Level (1.0m on machine side)

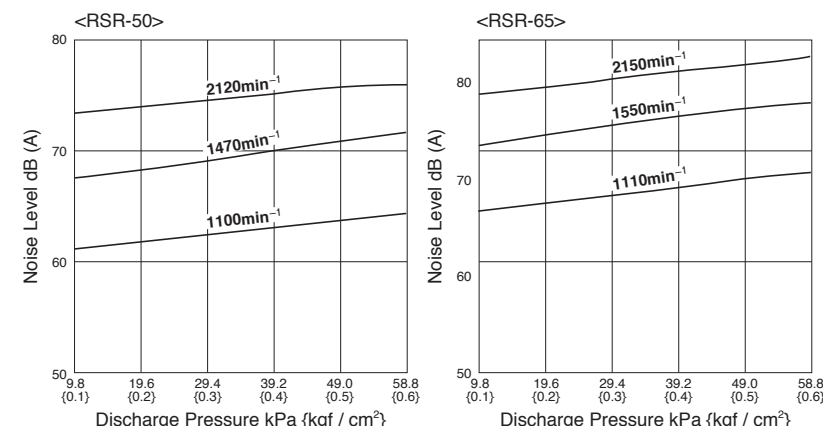

Applications

- Supplying oxygen to wastewater in aeration tank
- Supplying oxygen in aquaculture

Major Standard Specifications

Discharge Bore		mm	50	65
Treating Fluid	Type of Fluid	Air		
	Fluid Temperature	0 to 40°C		
Blower	Structure	Rotor	3-lode Helical Port	
		Shaft Seal	Labyrinth	
	Materials	Bearing	Ball Bearing	
		Shaft	Carbon Steel	
Motor	Type, Pole	Drip-proof Motor 4-pole		
	Class of Insulation	Class E		
	Phase	Three-phase		
Discharge Connection		JIS 10K Flange		

Standard Specifications

Model (Discharge bore mm)	Revolutions (min ⁻¹)	Suction air volume at 20°C(Qs, m ³ /min) and required power (La, kW)																							
		9.8kPa {0.10kgf/cm ² }		14.7kPa {0.15kgf/cm ² }		19.6kPa {0.20kgf/cm ² }		24.5kPa {0.25kgf/cm ² }		29.4kPa {0.30kgf/cm ² }		34.3kPa {0.35kgf/cm ² }		39.2kPa {0.40kgf/cm ² }		44.1kPa {0.45kgf/cm ² }		49.0kPa {0.50kgf/cm ² }		53.9kPa {0.55kgf/cm ² }		58.8kPa {0.60kgf/cm ² }			
		Qs	La	Qs	La	Qs	La	Qs	La	Qs	La	Qs	La	Qs	La	Qs	La	Qs	La	Qs	La	Qs	La	Qs	La
RSR-50 (50)	1100	1.19	0.26	1.13	0.40	1.08	0.54	1.03	0.68	0.99	0.82	0.95	0.96	0.92	1.10	0.89	1.24	0.86	1.38	—	—	—	—		
	1230	1.36	0.36	1.30	0.51	1.25	0.66	1.20	0.81	1.16	0.96	1.12	1.11	1.08	1.26	1.05	1.41	1.02	1.56	0.99	1.71	—	—		
	1350	1.51	0.47	1.46	0.63	1.41	0.79	1.36	0.95	1.32	1.11	1.28	1.27	1.24	1.43	1.20	1.59	1.17	1.75	1.13	1.91	—	—		
	1470	1.68	0.63	1.63	0.79	1.59	0.95	1.54	1.11	1.50	1.28	1.46	1.44	1.43	1.60	1.39	1.76	1.35	1.93	1.32	2.09	1.29	2.26		
	1560	1.81	0.75	1.77	0.91	1.73	1.08	1.69	1.24	1.65	1.41	1.61	1.57	1.58	1.74	1.54	1.90	1.50	2.07	1.47	2.23	1.43	2.40		
	1660	1.93	0.80	1.89	0.98	1.85	1.16	1.81	1.33	1.77	1.51	1.73	1.69	1.69	1.87	1.65	2.05	1.61	2.23	1.58	2.40	1.54	2.58		
	1750	2.04	0.85	2.00	1.04	1.96	1.23	1.92	1.42	1.88	1.61	1.84	1.80	1.80	1.99	1.76	2.18	1.72	2.37	1.68	2.56	1.64	2.75		
	1850	2.17	0.99	2.13	1.18	2.09	1.37	2.05	1.57	2.01	1.76	1.97	1.95	1.93	2.14	1.89	2.34	1.85	2.53	1.81	2.71	1.77	2.91		
1960	2.32	1.14	2.28	1.34	2.24	1.53	2.20	1.73	2.16	1.92	2.12	2.12	2.08	2.31	2.04	2.51	2.00	2.70	1.96	2.90	1.92	3.09			
2120	2.52	1.41	2.47	1.62	2.42	1.82	2.38	2.03	2.33	2.23	2.29	2.44	2.24	2.64	2.20	2.85	2.16	3.05	2.12	3.26	2.08	3.46			
Corresponding motor output		0.75kW				1.5kW				2.2kW				3.7kW											
RSR-65 (65)	1110	1.67	0.63	1.58	0.80	1.50	0.97	1.43	1.14	1.37	1.31	1.32	1.48	1.27	1.65	1.22	1.82	1.17	1.99	—	—	—	—		
	1240	1.91	0.70	1.84	0.89	1.76	1.08	1.68	1.27	1.62	1.46	1.56	1.65	1.51	1.84	1.46	2.03	1.41	2.22	1.36	2.41	—	—		
	1360	2.14	0.80	2.07	1.01	2.00	1.22	1.93	1.43	1.87	1.64	1.81	1.85	1.76	2.06	1.70	2.27	1.65	2.48	1.60	2.69	—	—		
	1460	2.35	0.88	2.27	1.11	2.20	1.33	2.13	1.55	2.07	1.78	2.01	2.00	1.96	2.22	1.90	2.45	1.85	2.67	1.80	2.90	1.76	3.13		
	1550	2.54	0.96	2.46	1.20	2.39	1.43	2.32	1.67	2.25	1.90	2.19	2.14	2.14	2.37	2.08	2.61	2.03	2.84	1.98	3.08	1.94	3.31		
	1670	2.75	1.05	2.68	1.31	2.62	1.56	2.56	1.82	2.49	2.07	2.43	2.33	2.38	2.58	2.33	2.83	2.28	3.08	2.23	3.34	2.19	3.59		
	1770	2.94	1.13	2.88	1.40	2.82	1.67	2.76	1.94	2.70	2.21	2.64	2.48	2.59	2.75	2.54	3.02	2.49	3.29	2.45	3.56	2.41	3.83		
	1860	3.13	1.24	3.07	1.52	3.00	1.80	2.94	2.08	2.88	2.36	2.82	2.65	2.76	2.93	2.71	3.22	2.66	3.50	2.61	3.78	2.57	4.07		
1980	3.39	1.38	3.32	1.68	3.25	1.98	3.18	2.28	3.12	2.57	3.06	2.87	3.00	3.18	2.94	3.48	2.89	3.78	2.84	4.08	2.80	4.38			
2150	3.65	1.60	3.58	1.93	3.52	2.25	3.46	2.58	3.40	2.90	3.34	3.23	3.28	3.55	3.22	3.88	3.17	4.20	3.12	4.53	3.08	4.85			
Corresponding motor output		1.5kW				2.2kW				3.7kW				5.5kW											

Standard Accessories

- Common Base
- Suction Silencer (with Air Filter)
- Safety Valve
- Pressure Gauge
- Foundation Bolts (with Nuts)

RSR 80 • 100mm



Performance Curves

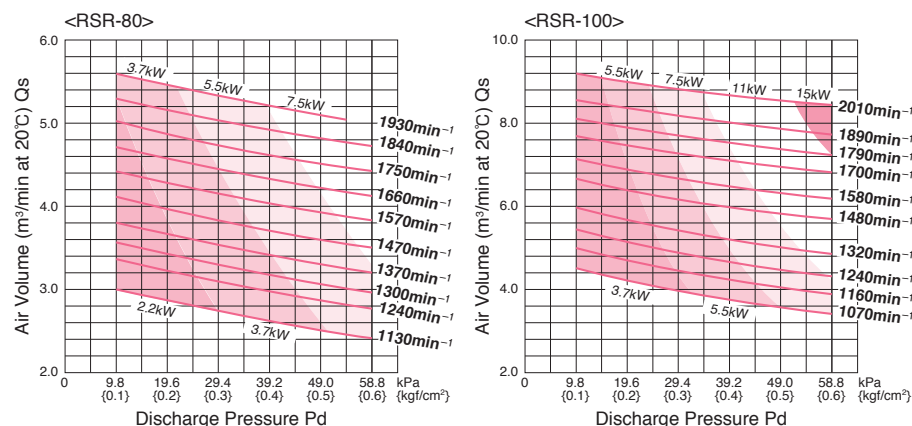

Noise Level (1.0m on machine side)

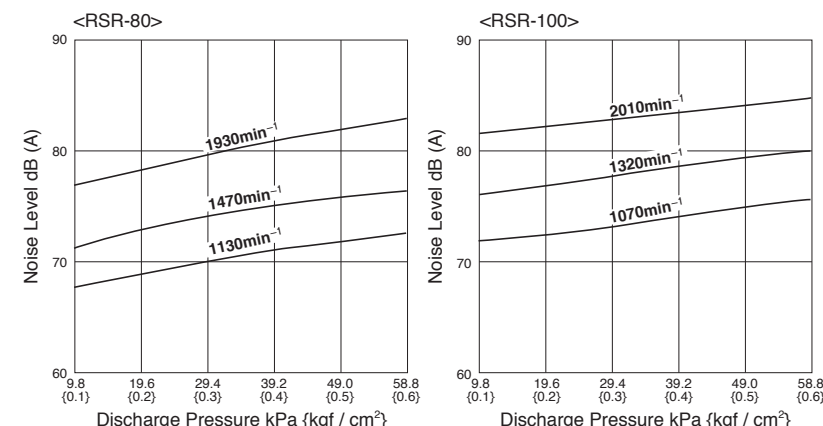

Applications

- Supplying oxygen to wastewater in aeration tank
- Supplying oxygen in aquaculture

Major Standard Specifications

Discharge Bore		mm	80	100
Treating Fluid	Type of Fluid	Air		
	Fluid Temperature	0 to 40°C		
Blower	Structure	Rotor	3-lode Helical Port	
		Shaft Seal	Labyrinth	
	Bearing	Ball Bearing		
	Materials	Rotor	Gray Iron Casting	
Casing		Gray Iron Casting		
Shaft		Carbon Steel		
Motor	Type, Pole	Drip-proof Motor		
		4-pole		
	Class of Insulation	Class E		
	Phase	Three-phase		
Discharge Connection		JIS 10K Flange		

Standard Specifications

Model (Discharge bore mm)	Revolutions (min ⁻¹)	Suction air volume at 20°C(Qs, m ³ /min) and required power (La, kW)																							
		9.8kPa		14.7kPa		19.6kPa		24.5kPa		29.4kPa		34.3kPa		39.2kPa		44.1kPa		49.0kPa		53.9kPa		58.8kPa			
		Qs	La	Qs	La	Qs	La	Qs	La	Qs	La	Qs	La	Qs	La	Qs	La	Qs	La	Qs	La	Qs	La	Qs	La
RSR-80 (80)	1130	2.99	0.77	2.93	1.10	2.86	1.43	2.80	1.76	2.73	2.09	2.67	2.42	2.61	2.75	2.55	3.08	2.50	3.41	2.45	3.74	2.41	4.07		
	1240	3.36	0.89	3.29	1.28	3.22	1.63	3.16	1.99	3.09	2.34	3.03	2.70	2.97	3.05	2.92	3.41	2.86	3.76	2.81	4.12	2.76	4.47		
	1300	3.56	1.03	3.49	1.40	3.42	1.77	3.36	2.14	3.29	2.50	3.23	2.88	3.17	3.24	3.12	3.62	3.06	3.98	3.01	4.35	2.96	4.72		
	1370	3.80	1.16	3.74	1.55	3.67	1.93	3.60	2.32	3.53	2.70	3.47	3.09	3.41	3.47	3.36	3.86	3.30	4.24	3.25	4.63	3.20	5.01		
	1470	4.12	1.30	4.04	1.72	3.97	2.13	3.90	2.55	3.83	2.96	3.77	3.38	3.71	3.79	3.66	4.21	3.60	4.62	3.55	5.04	3.50	5.45		
	1570	4.42	1.51	4.35	1.94	4.28	2.37	4.22	2.80	4.15	3.23	4.10	3.66	4.04	4.09	3.99	4.52	3.93	4.95	3.89	5.38	3.84	5.81		
	1660	4.72	1.69	4.65	2.14	4.58	2.59	4.52	3.04	4.45	3.49	4.40	3.94	4.34	4.39	4.29	4.84	4.23	5.29	4.18	5.74	4.13	6.19		
	1750	5.04	1.90	4.96	2.36	4.88	2.82	4.81	3.28	4.74	3.74	4.69	4.20	4.63	4.66	4.58	5.12	4.52	5.58	4.48	6.04	4.44	6.50		
	1840	5.31	2.07	5.24	2.56	5.17	3.05	5.11	3.54	5.07	4.03	4.99	4.52	4.93	5.01	4.88	5.50	4.82	5.99	4.78	6.48	4.73	6.97		
	1930	5.61	2.27	5.54	2.78	5.46	3.29	5.40	3.80	5.33	4.31	5.28	4.82	5.22	5.33	5.17	5.84	5.11	6.35	5.06	6.86	-	-		
	Corresponding motor output	2.2kW				3.7kW				5.5kW				7.5kW											
RSR-100 (100)	1070	4.51	1.20	4.37	1.70	4.22	2.20	4.09	2.70	3.96	3.20	3.83	3.70	3.75	4.20	3.67	4.70	3.58	5.20	3.50	5.70	3.42	6.20		
	1160	5.00	1.42	4.85	1.95	4.69	2.49	4.56	3.03	4.43	3.56	4.33	4.10	4.23	4.64	4.15	5.17	4.06	5.71	3.98	6.25	3.90	6.78		
	1240	5.45	1.56	5.29	2.13	5.12	2.70	4.99	3.27	4.86	3.84	4.76	4.41	4.66	4.98	4.57	5.55	4.48	6.12	4.40	6.69	4.32	7.26		
	1320	5.97	1.64	5.82	2.27	5.66	2.89	5.54	3.52	5.41	4.14	5.31	4.77	5.21	5.39	5.12	6.02	5.02	6.64	4.94	7.27	4.86	7.89		
	1480	6.67	1.77	6.53	2.47	6.39	3.13	6.28	3.86	6.17	4.49	6.08	5.25	5.99	5.85	5.92	6.64	5.84	7.21	5.77	8.03	5.70	8.57		
	1580	7.14	1.92	7.01	2.66	6.88	3.37	6.77	4.13	6.66	4.83	6.58	5.60	6.49	6.28	6.42	7.07	6.34	7.74	6.27	8.54	6.20	9.19		
	1700	7.71	2.09	7.59	2.88	7.47	3.66	7.37	4.45	7.26	5.23	7.19	6.02	7.11	6.80	7.03	7.59	6.94	8.37	6.88	9.16	6.82	9.93		
	1790	8.12	2.24	8.01	3.12	7.90	3.89	7.80	4.71	7.70	5.53	7.63	6.36	7.55	7.13	7.48	8.00	7.40	8.82	7.33	9.65	7.26	10.46		
	1890	8.58	2.41	8.48	3.28	8.38	4.14	8.29	5.01	8.19	5.87	8.12	6.74	8.05	7.60	7.98	8.47	7.90	9.33	7.83	10.20	7.76	11.06		
	2010	9.19	2.56	9.09	3.49	9.00	4.41	8.91	5.34	8.82	6.26	8.76	7.19	8.70	8.11	8.64	9.04	8.58	9.96	8.53	10.89	8.47	11.81		
	Corresponding motor output	3.7kW				5.5kW				7.5kW				11kW				15kW							

Standard Accessories

- Common Base
- Suction Silencer (with Air Filter)
- Safety Valve
- Pressure Gauge
- Foundation Bolts (with Nuts)

RSR 125 • 150mm



Performance Curves

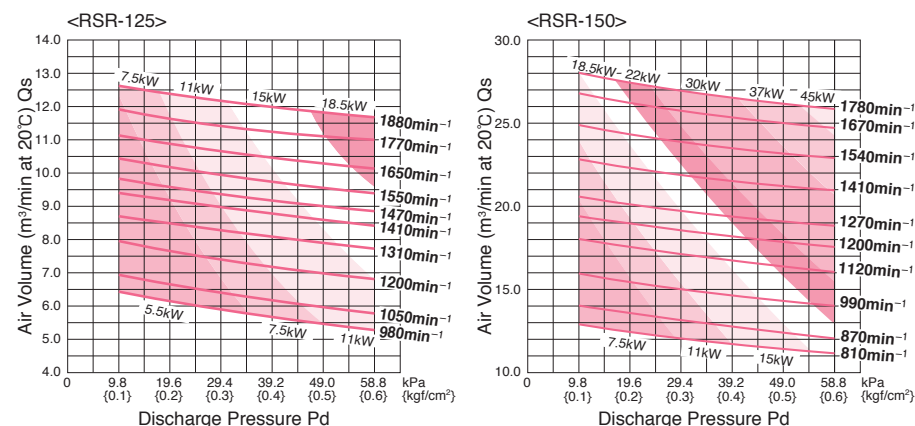

Noise Level (1.0m on machine side)

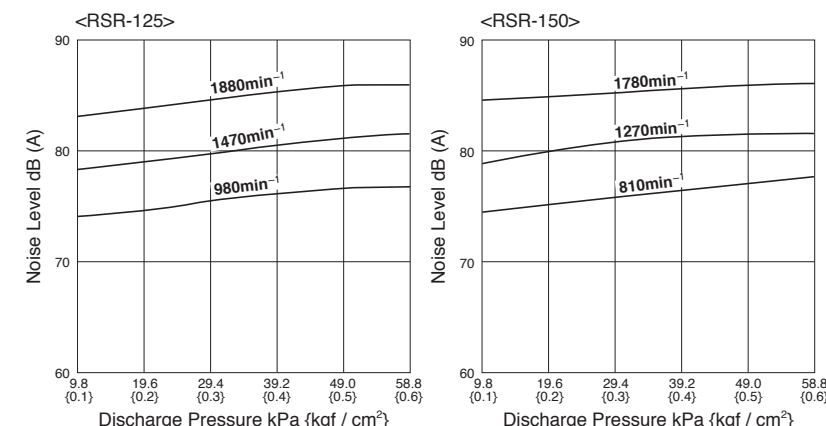

Applications

- Supplying oxygen to wastewater in aeration tank
- Supplying oxygen in aquaculture

Major Standard Specifications

Discharge Bore		mm	125	150
Treating Fluid	Type of Fluid	Air		
	Fluid Temperature	0 to 40°C		
Blower	Structure	Rotor	3-lode Helical Port	
		Shaft Seal	Labyrinth	
	Bearing	Ball Bearing		
	Materials	Rotor	Gray Iron Casting	
Casing		Gray Iron Casting		
Shaft		Carbon Steel		
Motor	Type, Pole	Drip-proof Motor		
		4-pole		
	Class of Insulation	Class E		
	Phase	Three-phase		
Discharge Connection		JIS 10K Flange		

Standard Specifications

Model (Discharge bore mm)	Revolutions (min ⁻¹)	Suction air volume at 20°C(Qs, m ³ /min) and required power (La, kW)																							
		9.8kPa		14.7kPa		19.6kPa		24.5kPa		29.4kPa		34.3kPa		39.2kPa		44.1kPa		49.0kPa		53.9kPa		58.8kPa			
		Qs	La	Qs	La	Qs	La	Qs	La	Qs	La	Qs	La	Qs	La	Qs	La	Qs	La	Qs	La	Qs	La		
RSR-125 (125)	980	6.41	1.80	6.26	2.46	6.12	3.12	5.98	3.78	5.86	4.44	5.74	5.10	5.63	5.76	5.52	6.42	5.43	7.08	5.34	7.74	5.26	8.40		
	1050	6.93	2.10	6.77	2.79	6.63	3.48	6.50	4.17	6.37	4.86	6.25	5.55	6.14	6.24	6.04	6.93	5.94	7.62	5.86	8.31	5.78	9.00		
	1200	7.94	2.70	7.79	3.48	7.65	4.25	7.53	5.03	7.40	5.80	7.29	6.58	7.18	7.35	7.07	8.13	6.98	8.90	6.89	9.68	6.81	10.45		
	1310	8.70	3.10	8.58	3.95	8.47	4.80	8.37	5.65	8.27	6.50	8.17	7.35	8.07	8.20	7.98	9.05	7.89	9.90	7.81	10.75	7.73	11.60		
	1410	9.40	3.39	9.28	4.31	9.17	5.22	9.06	6.13	8.96	7.04	8.86	7.95	8.76	8.86	8.67	9.77	8.58	10.68	8.50	11.59	8.42	12.50		
	1470	9.83	3.69	9.71	4.64	9.60	5.59	9.50	6.53	9.40	7.48	9.30	8.42	9.21	9.36	9.12	10.31	9.03	11.25	8.95	12.19	8.88	13.14		
	1550	10.44	3.90	10.31	4.90	10.19	5.90	10.07	6.90	9.96	7.90	9.86	8.90	9.76	9.90	9.67	10.90	9.58	11.90	9.50	12.90	9.43	13.90		
	1650	11.13	4.40	11.00	5.48	10.87	6.56	10.76	7.64	10.65	8.72	10.55	9.80	10.45	10.88	10.36	11.96	10.28	13.04	10.20	14.12	10.14	15.20		
1770	11.92	4.90	11.79	6.02	11.68	7.14	11.57	8.26	11.47	9.38	11.37	10.50	11.28	11.62	11.20	12.74	11.13	13.86	11.06	14.98	11.00	16.10			
1880	12.63	5.40	12.50	6.58	12.39	7.76	12.28	8.94	12.18	10.12	12.08	11.30	11.99	12.48	11.91	13.66	11.83	14.84	11.76	16.02	11.70	17.20			
Corresponding motor output		5.5kW		7.5kW		11kW		15kW		18.5kW															
RSR-150 (150)	810	12.90	2.91	12.65	3.75	12.42	4.59	12.21	5.54	12.02	7.50	11.85	8.89	11.69	10.27	11.53	11.60	11.38	12.93	11.25	14.06	11.14	15.19		
	870	14.13	3.13	13.84	4.51	13.58	5.90	13.33	7.12	13.10	8.67	12.89	10.05	12.69	11.43	12.51	12.82	12.34	14.20	12.19	15.59	12.05	16.97		
	990	15.92	3.34	15.67	4.90	15.44	6.46	15.22	8.02	15.01	9.58	14.81	11.14	14.63	12.70	14.46	14.26	14.30	15.82	14.15	17.38	14.02	18.94		
	1120	18.03	5.38	17.77	7.10	17.53	8.81	17.30	10.53	17.08	12.24	16.87	13.96	16.68	15.67	16.50	17.39	16.33	19.10	16.17	20.82	16.03	22.53		
	1200	19.39	6.32	19.14	8.06	18.91	9.80	18.69	11.53	18.49	13.27	18.29	15.01	18.12	16.75	17.95	18.49	17.79	20.23	17.65	21.97	17.52	23.71		
	1270	20.58	7.14	20.35	8.90	20.13	10.66	19.92	12.42	19.73	14.18	19.55	15.94	19.38	17.70	19.22	19.46	19.08	21.22	18.95	22.98	18.83	24.74		
	1410	22.81	9.01	22.57	11.01	22.35	13.01	22.14	15.01	21.94	17.01	21.75	19.01	21.58	21.01	21.42	23.01	21.27	25.01	21.13	27.01	21.01	29.01		
	1540	24.89	10.99	24.63	13.11	24.40	15.23	24.17	17.35	23.95	19.47	23.75	21.59	23.56	23.71	23.39	25.83	23.22	27.95	23.08	30.07	22.94	32.19		
1670	26.84	12.71	26.57	14.96	26.32	17.21	26.08	19.46	25.85	21.71	25.63	23.96	25.43	26.21	25.24	28.46	25.06	30.71	24.91	32.96	24.76	35.21			
1780	28.06	14.19	27.79	16.61	27.53	19.02	27.28	21.44	27.05	23.85	26.83	26.27	26.62	28.68	26.42	31.10	26.24	33.51	26.07	35.93	25.91	38.34			
Corresponding motor output		7.5kW		11kW		15kW		18.5kW		22kW		30kW		37kW		45kW									

Standard Accessories

- Common Base
- Suction Silencer (with Air Filter)
- Safety Valve
- Pressure Gauge
- Foundation Bolts (with Nuts)